



CDVI

NL NEDERLANDS

FR FRANS

I180SR
I400SR
I500SR
I180ER
I300ER
I500E

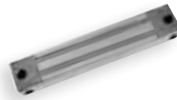

I180SR

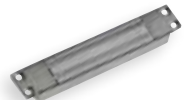

I180ER



I400SR



I300ER



I500SR



I500E

Inbouw- en opbouwmagneeten in roestvrij staal
Ventouses électromagnétiques appliquées et encastrées inox

The installer's choice
cdvigroup.com

I180SR - I400SR - I500SR - I180ER - I1300ER - I500E

Inbouw- en opbouwmagneten in roestvrij staal

Bedankt voor de aankoop van onze producten en het vertrouwen dat u in onze onderneming stelt.

1] PRODUCT PRESENTATIE

- **Roestvrij staal.**
- **Opbouw of inbouw*.**
- **Signaal*.**
- **Houdkracht:** 180, 300, 400 of 500kg*.
- **Veiligheidskabels*.**
- **Zeer hoge corrosieweerstand.**
- **Geleverd met ankerplaat.**
- **Geen mechanische slijtage.**
- **Installatiegemak.**
- **Aanbevolen voor buitengebruik.**
- **Fail safe (Deur ontgrendeld wanneer de spanning wegvalt).**
- **Ingebouwde varistor: bescherming tegen self-effect.**

- Afmetingen elektromagneten (L x b x h):
 - I180SR = 175 x 32,5 x 22mm,
 - I400SR = 230 x 43,5 x 29,5mm,
 - I500SR = 230 x 61 x 41mm.
 - I180ER = 201 x 32 x 22mm,
 - I300ER = 228 x 38 x 27mm,
 - I500E = 288,5 x 64 x 37,5mm.
- Afmetingen ankerplaat (L x b x h):
 - 180kg = 130 x 32 x 9mm,
 - 300kg = 185 x 38 x 11mm,
 - 400kg = 185 x 45 x 12mm,
 - 500kg = 185 x 60 x 12mm.
- Voeding: 12/24V dc.
- Verbruik:
 - 12 V DC = 550mA,
 - 24 V DC = 275mA.

Referenties	Houdkracht	Signaal
I180SR	180kg	✓
I400SR	400kg	✓
I500SR	500kg	✓
I180ER	180kg	✓
I300ER	300kg	✓
I500E	500kg	-

 EC certificatie

 IP54

 WEEE

 RoHS

Aanbevolen voedingen



2] HERINNERINGEN & AANBEVELINGEN

Een elektromagnetisch slot heeft als doel het vergrendelen van een toegangspunt te verzekeren. Dit document is een installatiegids die u in staat zal stellen om de installatie op een goede manier te voltooien.

REGELING MET BETREKKING TOT NOODUITGANGEN

Wanneer het elektromagnetisch slot op nooduitgangen geïnstalleerd wordt, is het noodzakelijk om na te gaan of deze uitgangen automatisch vrij zullen komen in geval van een brandalarm, zodat ze geopend kunnen worden in geval van brand en personen in het gebouw kunnen geëvacueerd worden. Het elektromagnetisch slot dat geïnstalleerd wordt op nooduitgangen moet in overeenstemming zijn met de plaatselijke brandweernormen.

Contacteer CDVI of de preventieadviseur van het gebouw voor meer informatie.

* Afhankelijk van de versie.

I180SR - I400SR - I500SR - I180ER - I1300ER - I500E

Inbouw- en opbouw magneten in roestvrij staal

VOEDING

Een elektromagnetisch slot werkt altijd op DC stroom, een erg lage en veilige spanning. Het elektromagnetisch slot wordt aanbevolen voor gebruik met voedingen die gefabriceerd werden door CDVI. Voedingen van andere fabrikanten kunnen echter ook gebruikt worden op voorwaarde dat ze van een gelijkaardige kwaliteit zijn, ze gelijkgericht, gefilterd, niet geregeld, primair en secundair beschermd zijn met automatische zekeringen.

AANBEVELINGEN VOOR INSTALLATIE

- Definieer het beveiligingsniveau voor de toegang.
- Bepaal de maximum houdkracht voor dit beveiligingsniveau.
- Selecteer het elektromagnetisch slot op basis van de omgeving: binnenkant, buitenkant, de klimatologische beperkingen (Bijvoorbeeld: roestvrij staal voor buitengebruik).
- Installeer het elektromagnetisch slot altijd op de veilige kant van de te beveiligen ruimte.
- Zorg ervoor dat het deurkader en de deuropening die voorzien zullen worden van het elektromagnetisch slot, de ankerplaat en accessoires stevig zijn en bestand zijn tegen schade of slijtage.
- Pas de montage-onderdelen aan in functie van het type ondersteuning voor de magneet en ankerplaat (schroeven, spijkers, accessoires)
- Definieer de kabeldoorgangen om de installatie te beveiligen tegen vandalisme en omgevingsomstandigheden (flexibele deurslangen, goten, cross kabels, plastic buizen).

Ankerplaat

- Het is noodzakelijk om de elektromagneet en de ankerplaat stevig op hun steun te installeren.
- Installeer de magneet en de ankerplaat recht tegenover elkaar om de houdkracht te optimaliseren.
- De ankerplaat moet een beetje loshangen, zodat ze licht kan pivoteren rond haar centrale montagevijs. Hierdoor kan een slechte deuruitlijning gecompenseerd worden.

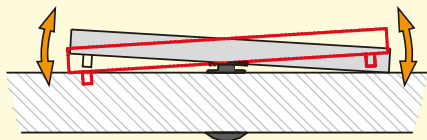

Beveiligingskabels

De elektromagneet is onderhevig aan herhaaldelijke schokken en vibraties op de punten waar het bevestigd is op het deurkader (openings- en sluitingsfrequenties/pogingen tot vandalisme), waardoor de bevestigingsbouten- en vijzen kunnen loskomen. Om te voorkomen dat de elektromagneet naar beneden zou vallen, installeert u het best de twee bijgeleverde beveiligingskabels. Op die manier verzekert u de veiligheid van de voorbijgangers (zie plan in bijlage).

Beveiligingskabels

(te bevestigen aan de elektromagneet en het deurkader)

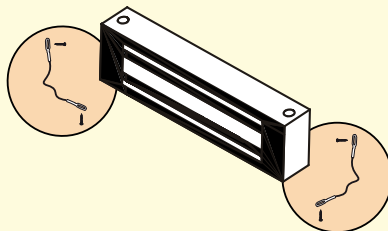

ONDERHOUD













De elektromagneet en ankerplaat vergen een specifiek onderhoud, dat ervoor zorgt dat ze beschermd blijven tegen slijtage en corrosie. Deze producten hebben geen groot onderhoud nodig, maar om een optimale werking te garanderen raden we u toch aan om de oppervlakten die in contact komen met de elektromagneet en ankerplaat regelmatig te kuisen met een doek en niet-schurende producten. Indien corrosiesporen verschijnen, raden we u aan om de contactoppervlakten te reinigen en in te oliën. Controleer alle bevestigingen van de elektromagneet regelmatig en span ze regelmatig aan. Wij raden aan om alle bouten te voorzien van borgmiddel.

I180SR - I400SR - I500SR - I180ER - I1300ER - I500E













Inbouw- en opbouw magneten in roestvrij staal

3] INHOUD PAKKET











VERSIE I180ER

								
Inbouw elektromagneet	Ankerplaat	Vijs 5x8 in roestvrij staal	Dopmoer	Hulpstuk	Schroef (RVS) met rubberen sluitring 5x35	Rolpen (RVS) 5x16	Sluitring in roestvrij staal 6x13	Rubberen sluitring 6x10
1	1	8	1	1	1	2	2	1
								
Afstel plaat	3mm sleutel	Installatie handleiding						
2	1	1						

VERSIE I300ER

											
Inbouw elektromagneet	Ankerplaat	Vijs 5x8 in roestvrij staal	Dopmoer	Hulpstuk	Schroef (RVS) met rubberen sluitring 8x25	Rolpen (RVS) 5x16	Sluitring in roestvrij staal 10x22	Sluitring in roestvrij staal 9x15	Afstel plaat	5mm sleutel	Installatie handleiding
1	1	8	1	1	1	2	2	1	2	1	1





















VERSIE I500E

										
Inbouw elektromagneet	Ankerplaat	Vijs 5x8 in roestvrij staal	Dopmoer	Hulpstuk	Schroef (RVS) met rubberen sluitring 8x25	Roll pen (RVS) 5x16	Sluitring in roestvrij staal 10x22	Rubberen sluitring 9x15	5mm sleutel	Installatie handleiding
1	1	8	1	1	1	2	2	1	1	1



















I180SR - I400SR - I500SR - I180ER - I1300ER - I500E

Inbouw- en opbouw magneten in roestvrij staal

VERSIE I180SR

											
Opbouw elektromagneet	Ankerplaat	Bevestigingsplaat	Schroef (RVS) 3x10 (beveiligingskabels)	Dopmoer	Hulpstuk	Stalen schroefmoer 6x11	Afdichtingsplug	Zwarte stalen schroef 5x35	Schroef in RVS 5x35	Schroef in RVS met rubberen sluitring 5x35	Rolpen (RVS) 5x16
1	1	1	2	1	1	1	4	1	2	1	2
											
Steun (RVS) 10x15	Sluitring in RVS 6x13	Hol afdekkap	Sluitring 6x10	3mm sleutel	4mm sleutel	Beveiligingskabel	Installatie handleiding				
2	2	4	1	1	1	2	1				

I400SR - I500SR

											
Opbouw elektromagneet	Ankerplaat	Schroef (RVS) 3x10 (beveiligingskabels)	Dopmoer	Hulpstuk	Stalen schroefmoer 6x11	Afdichtingsplug	Zwarte stalen schroef 6x35	Schroef in RVS 6x40	Schroef in RVS 6x50	Schroef (RVS) met rubberen sluitring 8x35	Rolpen (RVS) 5x16
1	1	2	1	1	1	4	1	2	2	1	2
											
Sluitring in RVS 10x22	Steun (RVS) 10x15	Hol afdekkap	Rubberen sluitring 9x15	5mm sleutel	Beveiligingskabel	Installatie handleiding					
2	2	4	1	1	2	1					

I180SR - I400SR - I500SR - I180ER - I1300ER - I500E

Inbouw- en opbouwmagneten in roestvrij staal

4] OPTIONELE ACCESSOIRES (ENKEL VOOR ANKERPLAAT)

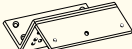
	OPBOUW	
		
Referenties	Z1	Z3Z4Z5
Omschrijving	"Z" beugel voor 180kg	"Z" beugel voor 300, 400 en 500kg

5] ELEKRISCHE VERBINDINGEN

Aansluit klem	Komt overeen met	I500E	I180ER - I180SR I300ER - I400SR I500SR
+	12 of 24V dc	■	■
-	- 0 V	■	■
N.C	NC (Normaal gesloten)	-	■
COM	COM	-	■
N.O	NO (Normaal open)	-	■

Het NO/NC signaal schakelt alleen wanneer de deur gesloten is en voorzien wordt van spanning.

BELANGRIJK

 **12V dc fabrieksinstelling**

Controleer de jumper positie alvorens het slot met de stroomingang te verbinden. Een verkeerde positie zou het slot kunnen beschadigen. Dit type schade wordt niet gedekt door de garantie.

MET INGEBOUWD PCB BORD

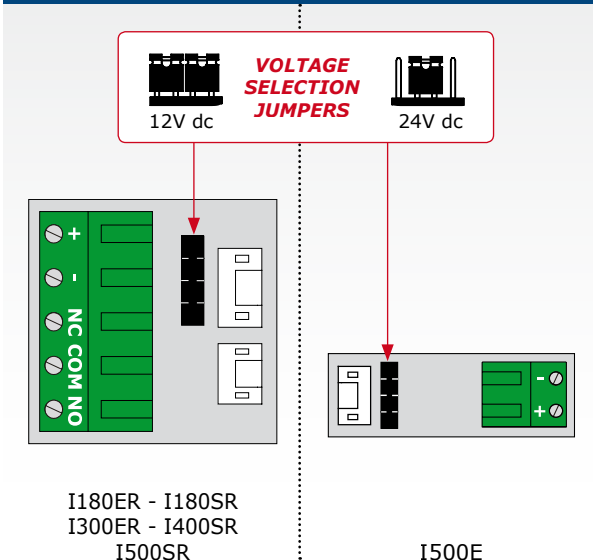

DIRECTE VERBINDING

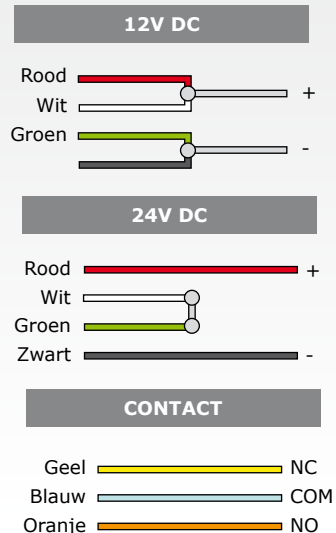

I180SR - I400SR - I500SR - I180ER - I1300ER - I500E

Inbouw- en opbouw magneten in roestvrij staal

6] INSTALLATIE

OPBOUW VERSIES: I180SR - I300SR - I400SR - I500SR

Montage van de afdichtingsplug

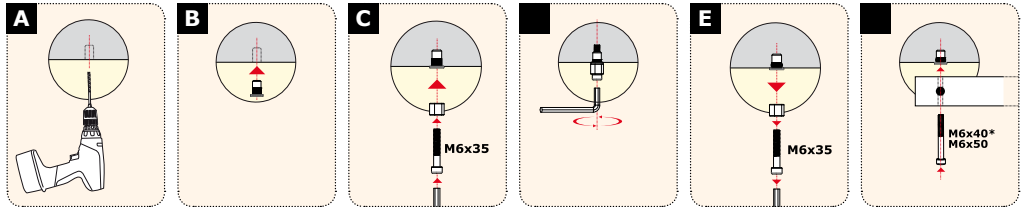

**Naargelang versies.*

Installatie van opbouw elektromagneten

VERTICALE OPBOUW

FRONTALE OPBOUW

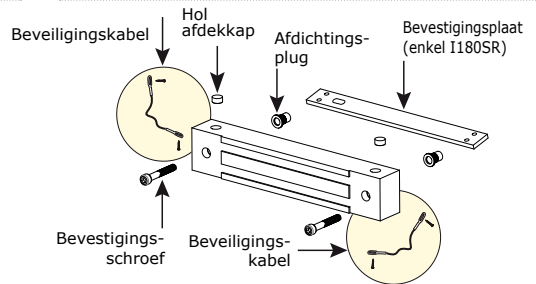
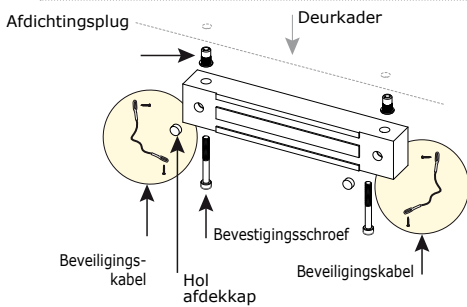

Installatie op een naar buiten draaiende deur (Duw deur)

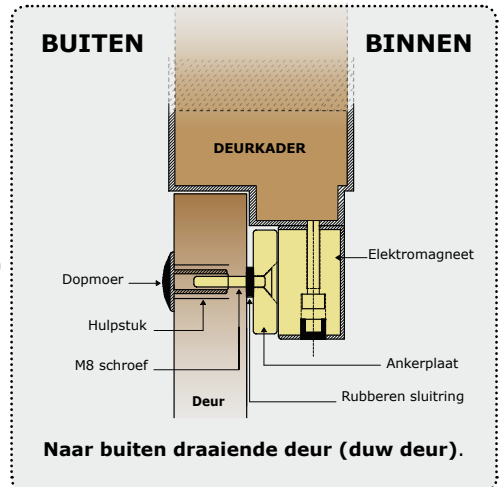
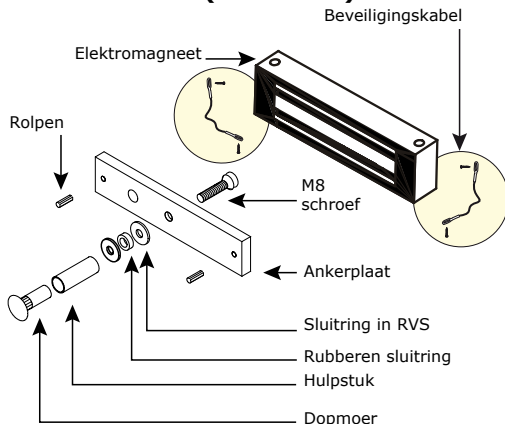

I180SR - I400SR - I500SR - I180ER - I1300ER - I500E

Inbouw- en opbouw magneten in roestvrij staal

Installatie op een naar binnen draaiende deur (Trek deur)

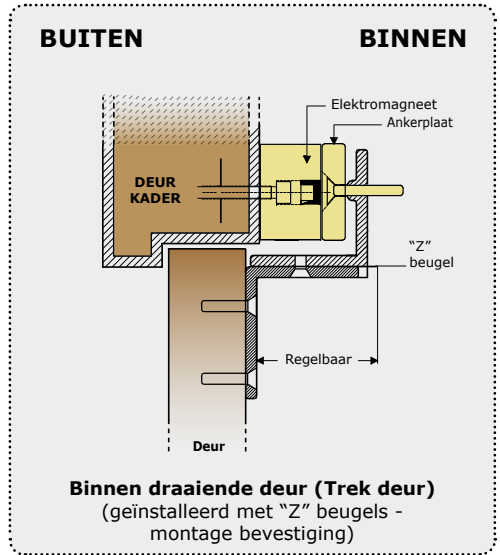
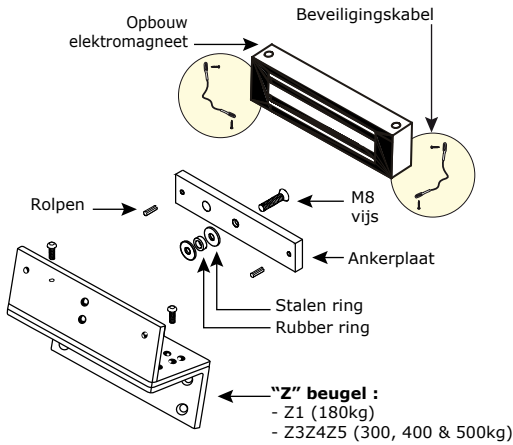

OPBOUW VERSIES: I180ER - I300ER - I500E

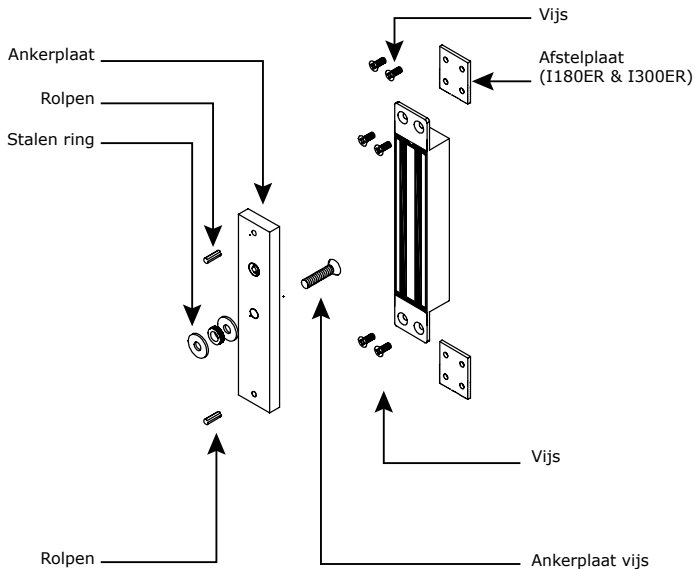

7] FOUTEN OPSPOREN

PROBLEEM	MOGELIJKE OORZAAK	OPLOSSING
Sluiten van deur onmogelijk	Het slot ontvangt geen DC stroom.	<ul style="list-style-type: none"> - Controleer of de kabels met de juiste aansluitklemmen verbonden zijn. - Controleer of de spanningstoever compatibel is. - Controleer of het slot correct verbonden is op het circuit.
Verminderde houdkracht	Het slot en de ankerplaat zijn niet correct met elkaar uitgelijnd.	<ul style="list-style-type: none"> - Controleer of het slot correct verbonden is op het circuit. - Controleer of de elektromagneet en de ankerplaat correct zijn uitgelijnd. - Controleer of het contactoppervlak vrij is van vuil en roest. - Controleer of de ankerplaat vrij is van beweging.
	Lage spanning of ankerplaat zit vast.	<ul style="list-style-type: none"> - Controleer of het slot de juiste/voldoende spanning krijgt. - Controleer de aanspanning van de ankerplaat en de toestand van het rubber.
Defecte reed contact	Spanning te laag. Verkeerde uitlijning.	<ul style="list-style-type: none"> - Controleer de spanningstoever. - Kabelsectie te bepalen al naargelang de spanningstoever en sluiting. - bv.: $2 \times 1.5\text{mm}^2 \geq 10\text{m}$.

9] NOTA'S

.....

.....

.....

.....

.....

.....

.....

.....

.....

.....

.....

.....

.....

.....

.....

.....

.....

.....

.....

.....

I180SR - I400SR - I500SR - I180ER - I1300ER - I500E

Ventouses électromagnétiques appliquées et encastrées inox

Merci pour l'achat de ce produit et pour la confiance que vous accordez à notre entreprise.

1] PRESENTATION DU PRODUIT

- **Inox.**
- **Applique ou encastrée*.**
- **Signal*.**
- **Force de rétention** : 180, 300, 400 ou 500 kg*.
- **Filin de sécurité*.**
- **Haute résistance à la corrosion.**
- **Livrée avec contre-plaque.**
- **Pas d'usure mécanique.**
- **Facilité d'installation.**
- **Préconisée en extérieur.**
- **Sécurité positive (libère instantanément l'accès en cas de coupure de courant).**
- **Varistance incorporée** : Protection électronique intégrée contre l'effet de self.
- Dimensions des ventouses (L x l x P) :
 - I180SR = 175 x 32,5 x 22 mm,
 - I400SR = 230 x 43,5 x 29,5 mm,
 - I500SR = 230 x 61 x 41 mm.
 - I180ER = 201 x 32 x 22 mm,
 - I300ER = 228 x 38 x 27 mm,
 - I500E = 288,5 x 64 x 37,5 mm.
- Dimensions des contre-plaques (L x l x P) :
 - 180 kg = 130 x 32 x 9 mm,
 - 300 kg = 185 x 38 x 11 mm,
 - 400 kg = 185 x 45 x 12 mm,
 - 500 kg = 185 x 60 x 12 mm.
- Alimentation : 12/24 V DC.
- Consommation :
 - 12 V DC = 550 mA,
 - 24 V DC = 275 mA.

Réfs	Force de rétention	Signal
I180SR	180 kg	✓
I400SR	400 kg	✓
I500SR	500 kg	✓
I180ER	180 kg	✓
I300ER	300 kg	✓
I500E	500 kg	-

 Certification CE

 IP54

 DEEE

 RoHS

Alimentations préconisées



2] RAPPELS ET RECOMMANDATIONS

La fonction d'une ventouse électromagnétique est d'assurer le verrouillage d'un accès. Ce document est un guide de pose qui vous permettra de sécuriser l'installation en fonction des caractéristiques du produit, du site et des contraintes environnementales.

NORME INCENDIE RELATIVE AUX ISSUES DE SECOURS

Dans le cas d'une installation de ventouses électromagnétiques sur des issues de secours, il est impératif de s'assurer que ces accès seront automatiquement libres en cas d'alarme incendie, pour permettre une évacuation des lieux. Les ventouses électromagnétiques installées sur des issues de secours doivent impérativement être conformes à la norme incendie locale (Ex : En France = NFS 61-937).

Pour plus d'informations, rapprochez-vous de CDVI, de l'organisme certifié local ou du centre de sécurité du bâtiment.

* Selon version.

I180SR - I400SR - I500SR - I180ER - I1300ER - I500E

Ventouses électromagnétiques appliquées et encastrées inox

ALIMENTATION

Une ventouse électromagnétique fonctionne toujours en courant continu, impérativement en très basse tension de sécurité (TBTS). Les ventouses électromagnétiques Diax® sont préconisées avec les alimentations de la gamme CDVI, toutefois, d'autres alimentations peuvent être utilisées à la condition que celles-ci présentent une qualité et des caractéristiques équivalentes, notamment redressée, filtrée, régulée, protégé par fusible en primaire et secondaire...

CONSEIL D'INSTALLATION

- Définir le niveau de sécurité de l'accès.
- Adapter la force de rétention maximum à ce niveau de sécurité.
- Sélectionner la ventouse électromagnétique Diax® en fonction de l'environnement, intérieur, extérieur, contraintes climatiques, ... (Par exemple : inox dédiée à une utilisation extérieure).
- Installer toujours la ventouse à l'intérieur du lieu à sécuriser.
- Bien s'assurer que le dormant et l'ouvrant, recevant ou supportant la ventouse, la contreplaque et leurs accessoires, soient solides et résistants dans le temps.
- Adapter les éléments de montage en fonction du type de support recevant la ventouse et la contreplaque (visserie, chevilles, accessoires,...).
- Définir le passage des câbles pour en assurer la protection contre le vandalisme et les contraintes environnementales (notamment par l'intermédiaire de flexible de porte, presse-étoupe, goulotte, passe câble, tube plastique, ...).

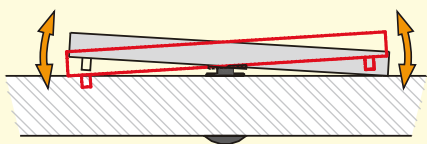

La contreplaque

- Il est vital de fixer solidement la ventouse et la contreplaque sur leurs supports.
- Mettre en vis-à-vis la ventouse et sa contreplaque pour optimiser la force de rétention.
- La contreplaque doit être montée "flottante", pour compenser un mauvais alignement de la porte.

Les filins de sécurité

La ventouse électromagnétique subit tout au long de sa vie une accumulation de chocs répétés et de sollicitations aux niveaux des points de fixation sur le dormant, fréquences d'ouvertures/fermetures, (tentative d'ouverture porte verrouillée et tentative de vandalisme) ce qui peut générer sa désolidarisation du support au moment de l'ouverture. Afin de pallier au risque de chute du bloc ventouse, installer les deux filins de sécurité fournis pour garantir la sécurité des utilisateurs (voir schéma).

Filins de sécurité (fixations sur ventouse et bâti)

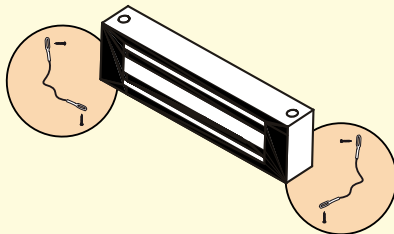







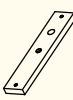

ENTRETIEN

La ventouse et sa contreplaque disposent d'un revêtement spécifique qui renforce la protection contre l'usure et la corrosion. Ces produits nécessitent donc peu d'entretien. Néanmoins pour assurer une fonctionnalité optimum, il est recommandé de nettoyer régulièrement les surfaces en contact de la ventouse et de sa contreplaque avec un chiffon et produits non abrasifs. Si des traces de corrosion venaient à apparaître, il est recommandé de nettoyer et huiler légèrement ces mêmes surfaces en contact. Vérifier et resserrer régulièrement l'ensemble des fixations de la ventouse. Il est nécessaire de mettre un frein-filet sur la vis pivot de la contreplaque.

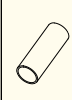
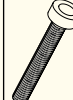
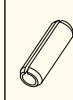









I180SR - I400SR - I500SR - I180ER - I1300ER - I500E
Ventouses électromagnétiques appliquées et encastrées inox

3] ÉLÉMENTS INCLUS

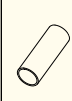

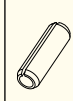

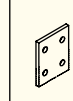





VERSION I180ER

								
Ventouse encastrée	Contre-plaque	Vis inox M5x8	Ecrin borgne M5	Embout de guidage	Vis inox avec caoutchouc M5x35	Goupille inox 5x16	Rondelle inox 6x13	caoutchouc 6x10
1	1	8	1	1	1	2	2	1
								
Patte de mise en affleurement	Clé 3 mm	Notice						
2	1	1						

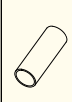
VERSION I300ER

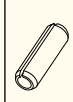



















											
Ventouse encastrée	Contre-plaque	Vis inox M5x8	Ecrin borgne	Embout de guidage	Vis inox avec caoutchouc M8x25	Goupille inox 5x16	Rondelle inox 10x22	caoutchouc 9x15	patte de mise en affleurement	Clé 5 mm	Notice
1	1	8	1	1	1	2	2	1	2	1	1

VERSION I500E



















										
Ventouse encastrée	Contre-plaque	Vis inox M5x8	Ecrin borgne	Embout de guidage	Vis inox avec caoutchouc M8x25	Goupille inox 5x16	Rondelle inox 10x22	caoutchouc 9x15	Clé 5 mm	Notice
1	1	8	1	1	1	2	2	1	1	1

I180SR - I400SR - I500SR - I180ER - I1300ER - I500E
Ventouses électromagnétiques appliquées et encastrées inox

VERSION I180SR

											
Ventouse applique	Contre-plaque	Plaque de montage	Vis inox 3x10 (filins de sécurité)	Ecrrou borgne	Embout de guidage	Ecrrou de scellement 6x11	Cheville de scellement	Vis métal noir 5x35	Vis inox 5x35	Vis inox avec caoutchouc 5x35	Goupille inox 5x16
1	1	1	2	1	1	1	4	1	2	1	2
											
Entretoise inox 10x15	Rondelle inox 6x13	Cache trou	caoutchouc 6x10	Clé 3 mm	Clé 4 mm	Filin de sécurité	Notice				
2	2	4	1	1	1	2	1				

VERSIONS I400SR - I500SR

											
Ventouse applique	Contre-plaque	Vis inox 3x10 (filins de sécurité)	Ecrrou borgne	Embout de guidage	Ecrrou de scellement 6x11	Cheville de scellement	Vis métal noir 6x35	Vis inox 6x40	Vis inox 6x50	Vis inox avec caoutchouc 8x35	Goupille inox 5x16
1	1	2	1	1	1	4	1	2	2	1	2
											
Rondelle inox 10x22	Entretoise inox 10x15	Cache trou	caoutchouc 9x15	Clé 5 mm	Filin de sécurité	Notice					
2	2	4	1	1	2	1					

I180SR - I400SR - I500SR - I180ER - I1300ER - I500E
Ventouses électromagnétiques appliques et encastrées inox

4] ACCESSOIRES EN OPTION (SEULEMENT POUR LA CONTREPLAQUE)

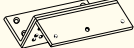
	VERSION APPLIQUE	
		
References	Z1	Z3Z4Z5
Description	Support en "Z" pour 180kg	Support en "Z" pour 300, 400 and 500kg

5] RACCORDEMENT

Bornier	Correspondance	I500E	I180ER - I180SR I300ER - I400SR I500SR
+	12 or 24 V DC	■	■
-	- 0 V	■	■
N.C	NC (Normalement fermé)	-	■
COM	COM	-	■
N.O	NO (Normalement ouvert)	-	■

Le signal NO/NC ne commute que lorsque la porte est fermée et sous tension.

NOTE IMPORTANTE

 **Réglage usine 12 V DC**

Vérifier la position du cavalier avant de brancher la ventouse au courant d'entrée. Une position incorrecte peut endommager la ventouse. Ce type de dommage n'est pas couvert par la garantie.

AVEC ÉLECTRONIQUE INTÉGRÉE

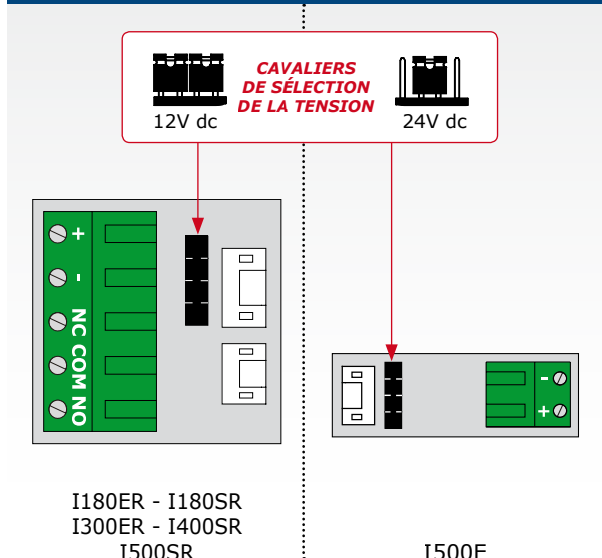

CONNEXION DIRECTE

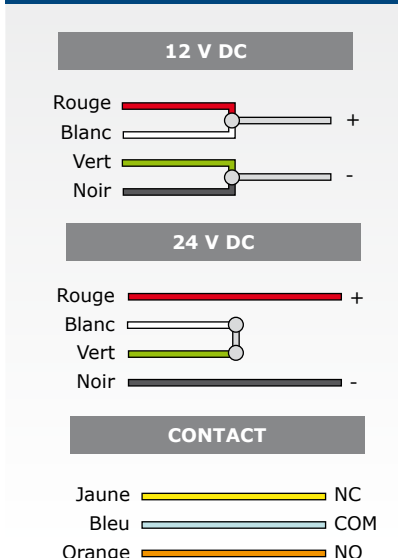

I180SR - I400SR - I500SR - I180ER - I1300ER - I500E
Ventouses électromagnétiques appliquées et encastrées inox

6] MONTAGE

VERSIONS APPLIQUES : I180SR - I300SR - I400SR - I500SR

Montage de la cheville de scellement

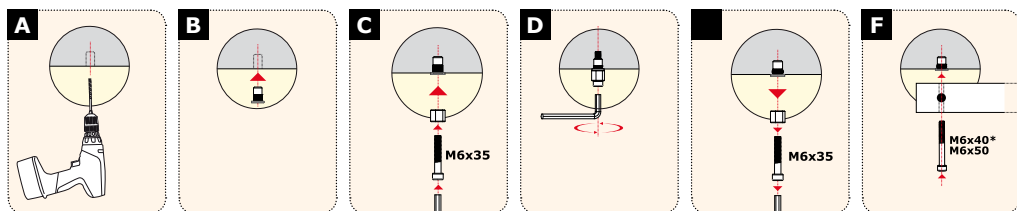

* Selon modèle.

Montage des ventouses appliquées

MONTAGE VERTICAL

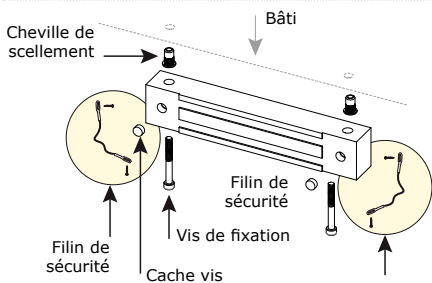

MONTAGE FACIAL

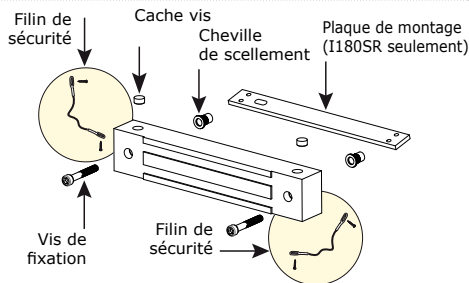

Montage sur porte à ouverture extérieure (Poussante)

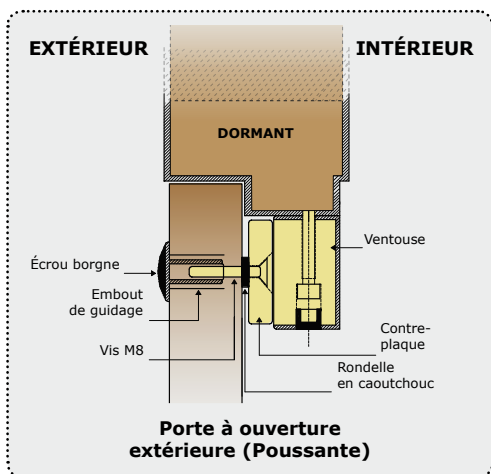
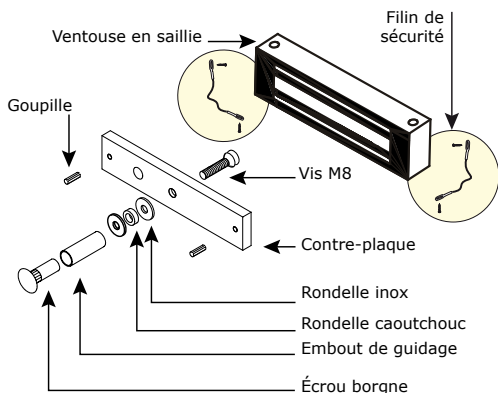

I180SR - I400SR - I500SR - I180ER - I1300ER - I500E
Ventouses électromagnétiques appliquées et encastrées inox

Montage sur porte à ouverture intérieure (Tirante)

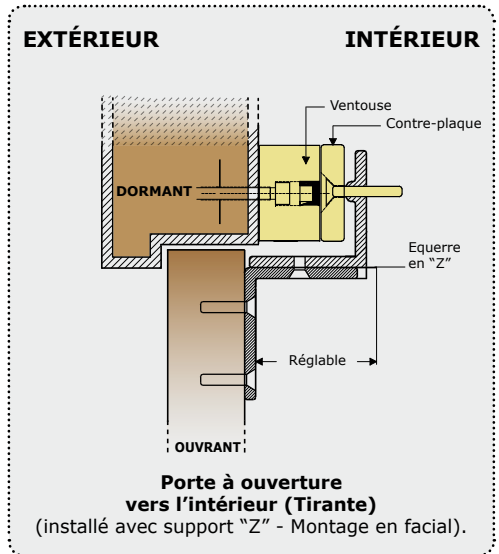
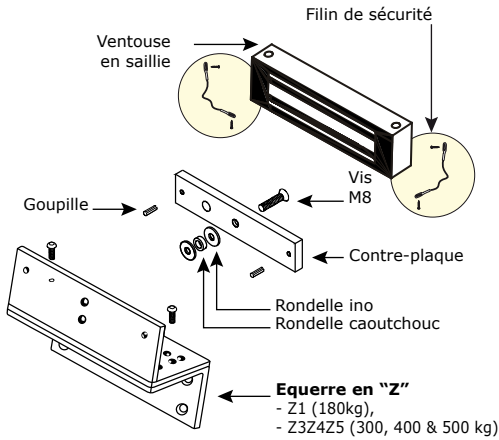

VERSIONS ENCASTRÉES : I180ER - I300ER - I500E

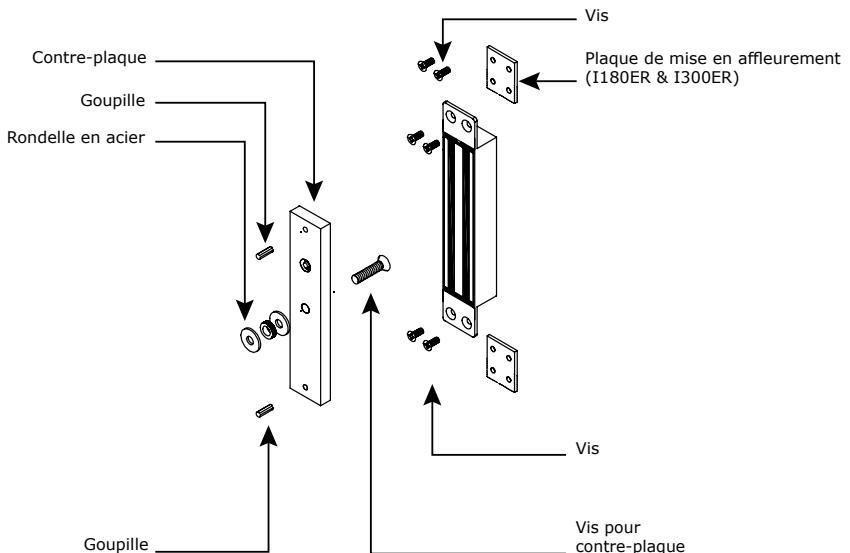

CDVI Benelux

Otegemstraat 241
8550 Zwevegem (België)
Tel.: +32 (0)56 73 93 00
Fax: +32 (0)56 73 93 05

***Neem contact met ons op/
Contactez-nous***

Bestellingen/Commandes

admin@cdvibenelux.com

Verkoop/Vente

info@cdvibenelux.com

Technische dienst/Support technique

techsupport@cdvibenelux.com

Marketing

marketing@cdvibenelux.com

Boekhouding / Comptabilité

info@cdvibenelux.com

Alle informatie op dit document (foto's, tekeningen, karakteristieken en afmetingen) kunnen onderhevig zijn aan wijzigingen zonder voorafgaande verwittiging.
Toutes les informations mentionnées à titre indicatif sur le présent document (photos, dessins, caractéristiques techniques et dimensions) peuvent varier et sont susceptibles de modifications sans notification préalable.