



LADY



ROAD BARRIERS

control unit with integrated receiver
built-in battery charger
external release

for passages up to 4 m

BENINCA



24 Vdc | intensive use

- 24 VDC electromechanical barrier for intensive use with control unit with integrated receiver, battery charger and extended range switching power supply from 100 to 250 VAC, 50/60 Hz
- Easy installation and possibility of quick connection for operation of opposed barriers, thanks to the SIS accessory board
- Reduced energy use on stand-by
- Possibility to install FTC.S photocells using concealed system so that they are perfectly integrated
- Simple, fast and reliable boom balancing system
- Adjustable slow-downs
- Available also in the stainless steel version, LADY.I

Foundation plate not included



CONTROL UNITS:

LADY ————— CP.LADY



RAL 2009

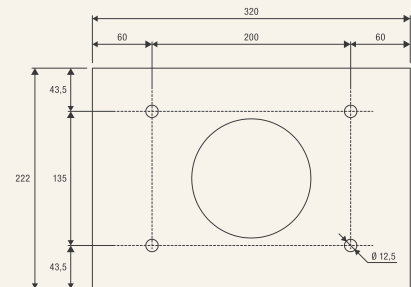
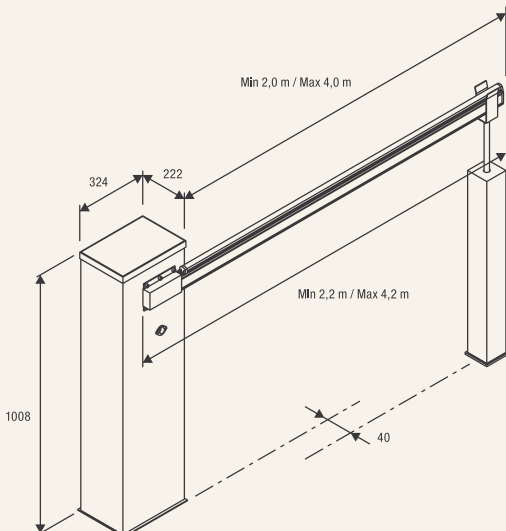

VE.PS

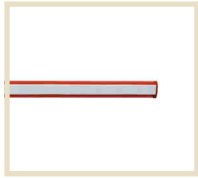

LADY.P
4.2 m white painted aluminium arm.

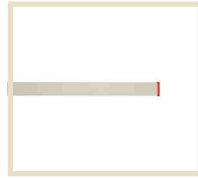

LADY.A
Aluminium arm measuring 4.2 m, with cap. Dimensions 60x38 mm.

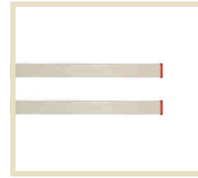

LADY.A2
Aluminium arm cut into two pieces measuring 2.1 m each. Dimensions 60x38 mm. Requires LADY.GT joint.



LADY.GT
LADY.A2 arm joint.



VE.PS
Foundation plate with coach screws.



VE.AM
Mobile support for arms.

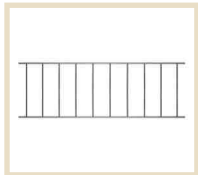

VE.RAST
Aluminium rack L= 2 m. H= 60 cm



VE.AF
Painted fixed support.
VE.AFI
Stainless steel fixed support.



LADY.COL
Support for the installation of a second pair of photocell.



LADY.SN
Articulated joint set for LADY.A / LADY.P (rubber profiles must be removed). It compromises the use of any other accessory.



LADY.L
Flashing light set for LADY.P.



VE.CS
Traffic-light control unit for LED.TL.



LED.TL
2 light 230 Vac LED traffic light.



SIS
Quick connection electronic board that allows synchronised movement of 2 automation devices (opposed barriers). One board for each motor is necessary.



DA.2S
Electronic board that allows synchronised movement of 2 automation devices (opposed barriers).



VE.KM1HN
Single channel loop detector.
VE.KM2HN
Two channels loop detector.



FTC.S
24 Vac/dc surface mounting photocell. It is possible to synchronise up to 4 pairs of photocells.



VE.CAT500
Set of 20 adhesive refractor strips.

AUTOMATISMI BENINCÀ SpA • Via del Capitello, 45 • 36066 Sandrigo (VI) ITALY • T +39 0444 751030 • sales@beninca.com

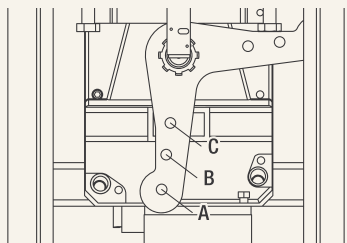

ACCESSORIES FOR USE	BAR LENGTH (m)				
	2.2	2.7	3.2	3.7	4.2
No accessories	C	C	C	B	A
LADY.P (only upper)	C	C	B	B	A
LADY.P (upper and lower)	C	C	B	B	A
VE.RAST	C	B	B	A	---
LADY.P (only upper) + VE.RAST	C	B	B	A	---
LADY.P (only upper) + VE.AM	C	B	B	A	A
LADY.P (upper and lower) + VE.AM	C	B	B	A	---
LADY.P (only upper) + VE.RAST + VE.AM	C	B	A	---	---
SC.RES	C	B	B	A	---
LADY.P (only upper) + SC.RES	C	B	A	A	---
SC.RES + VE.AM	C	B	A	A	---
LADY.P (only upper) + SC.RES + VE.AM	C	B	A	---	---

The installation of the VE.RAST interferes with the use of the SC.RES and vice versa.
The installation of the LADY.L lights kit does not influence the balancing of the bar.

TECHNICAL DATA	LADY
Power supply	100 ÷ 250 Vac (50-60Hz)
Motor supply	24 Vdc
Max absorbed current	1.5 A
Power consumption in stand-by	40 mA
Torque	195 Nm
Opening time	3.5" ÷ 6"
Duty cycle	intensive use
Protection level	IP44
Operating temperature	-20°C /+50°C
Weight	50.8 kg
Items no. per pallet	9