



# SAM

**Gearmotor 24 Vdc  
for swing gates  
with deep pillars  
ideal for residential use**

**BENINCA®**  
TECHNOLOGY TO OPEN

# SAM

24Vdc

24 Vdc gear motor with articulated arm for swing gates up to **2.5 m** or **300 kg** per leaf



## RESIDENTIAL USE

with built-in control unit, encoder and battery charger



## COMPLETE AND INNOVATIVE

Irreversible gear motor ideal for swing gates characterised by large-sized posts. The built-in control unit, easily accessible from above, is equipped with a **115/230 Vac 50/60 Hz switching power supply, that permits reduced power consumptions and a long lifespan of the operator**



## RELIABILITY AND INTEGRATED SAFETY

The **encoder** allows proper management of slowdowns, movement tracking (STC System), and torque management in relation to the position of the gate, which guarantees maximum safety



## MINIMUM SIZE. MAXIMUM ADAPTABILITY

Suitable for any setting thanks to reduced overall dimensions (only 170 mm of width)

## AESTHETIC AND FUNCTIONAL SOLUTIONS

Perfectly integrated release handle with front access, and lock covering with vertical scrolling. Possible release through a personalised key and an adjustable cable unlock device (accessory) that allows the opening from the outside in the event of a power failure



## CONTROL UNITS:

- SAM.E24 ——— CP.SAM
- SAM.24 ——— BRAINY24+  
BRAINY24  
HEADY24

# BENINCA

**100%**  
Made in Italy



## MINIMUM AND MAXIMUM INSTALLATION MEASURES

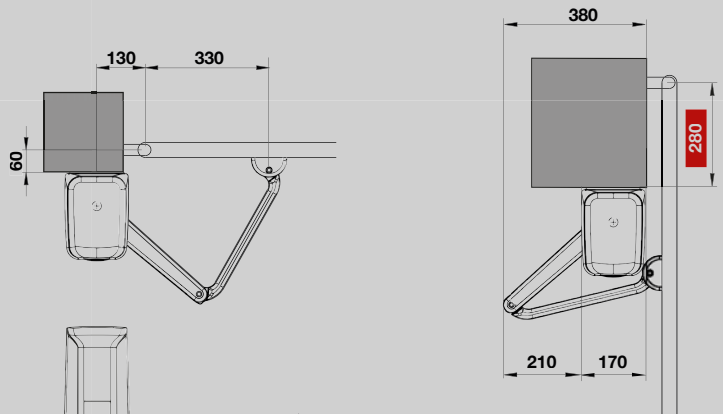
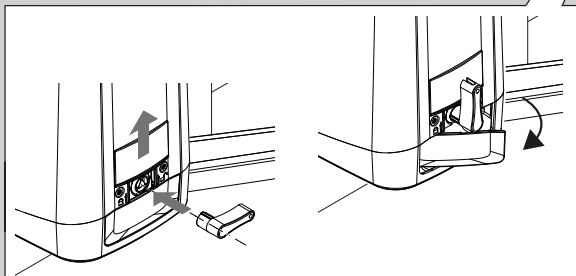

The operator allows reaching a distance between the leaf hinge and the surface of the post equal to 280mm: the biggest in the market. This results in the perfect adaptability of the actuator in contexts characterised by large-sized posts. In addition, the 34 mm bracket width allows mounting on gates even with only 40 mm posts.

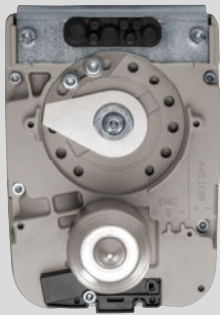

**MECHANICAL STOPS  
ADJUSTABLE FROM ABOVE**



**ARM WITH BUILT-IN LOCK FOR THE CLOSING,  
AND CROSS CONNECTION**

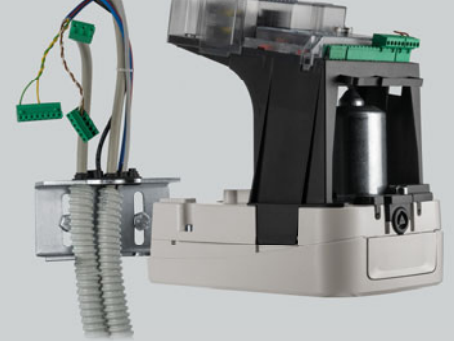

**FIXING BRACKET WITH  
RUBBER CABLE GLAND (INCLUDED)**

### ENERGY SAVING

The control unit is equipped with an innovative system to reduce energy consumption (ESA+), that guarantees an absorption in standby below 1 W

### EASY PROGRAMMING AND CONNECTIVITY

Designed for the integration with **KNX** home automation systems thanks to the **X.BE accessory**. Possible programming through the **BeUP** app by connecting the **PRO.UP interface**

### EASY AND QUICK INSTALLATION

The built-in control unit, accessible from above, is placed on a removable support that facilitates the installation and offers a quick access to the mechanical stops. In this way, the actuator can be installed flush with the floor

### SAFETY AND TECHNICAL SOLUTIONS

By fixing the bracket on the leaf in closed position with the arm completely stretched, the closing lock, integrated in the arm, allows defining the position of the limit switch for the closure. To make finer adjustments, a second lock, to be installed in the motor together with the one for the opening, is available as an accessory

### INSTALLATION DIAGRAM

1. GEAR MOTOR WITH INTERNAL CONTROL UNIT
2. GEAR MOTOR
3. FLASHING LIGHT
4. PHOTOCELLS
5. KEY SELECTOR OR DIGITAL KEYPAD

#### LIST OF CABLES

A	3x1,5mm <sup>2</sup>
B	2x1,5mm <sup>2</sup> 3x0,5mm <sup>2</sup>
C	2x0,5mm <sup>2</sup>
D	4x0,5mm <sup>2</sup>
E	4x0,5mm <sup>2</sup>
F	2x0,5 mm <sup>2</sup>
G	RG 58

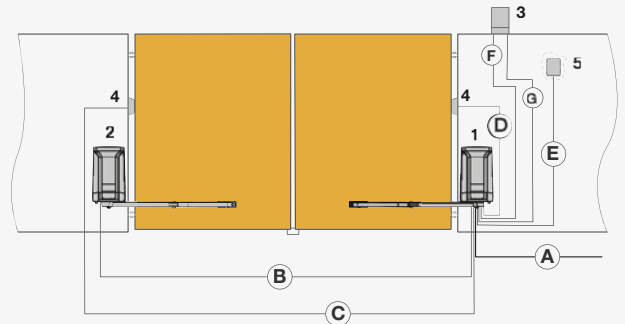

### INSTALLATION SCHEME WITH SAM.SN, JOINTED ARM FOR THE INSTALLATION IN SLOPING AREAS

These are the maximum values

The articulated arm accessory is ideal for installations on swing gates on sloping roads, where traditional arm movement would not be possible. PR.SN allows an oscillation of approximately 13°, allowing the movement to be adapted to the slope (up to 22.69%)

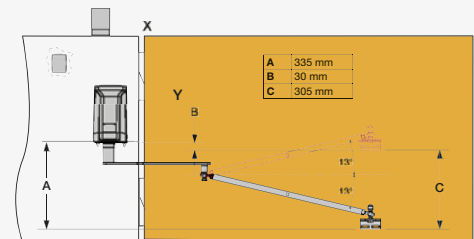

TECHNICAL DATA	SAM.24	SAM.E24
Power supply	---	115 Vac / 230 Vac (50-60Hz)
Motor supply	24 Vdc	24 Vdc
Max absorbed current	5 A	1.9 A
Torque	220 Nm	220 Nm
Opening time (90°)	14" (including slowdown)	14" (including slowdown)
Duty cycle	intensive use	intensive use
N° of cycles in 24h	120	120
N° of maximum cycles per hour	40 cycles/h	40 cycles/h
N° of maximum consecutive cycles	40	40
Protection level	IP44	IP44
Mechanical stop	adjustable in opening   closing, optional	adjustable in opening   closing, optional
Built-in control unit	NO	YES
Operating temperature	-20°C /+50°C	-20°C /+50°C
Weight	6 kg	7.9 kg

# CP.SAM

## CONTROL UNIT POWER SUPPLY

115/230 Vac - 50/60 Hz

## MOTORS POWER SUPPLY

24 Vdc

Automatic, semi-automatic and deadman's logic | Separate encoder inputs for each motor | Open, close, step by step, pedestrian and stop inputs | Autoset of operating parameters | Separate electronic torque adjustment for each motor | Anti-crushing safety through amperometric detection and encoder management | Electronic torque adjustment with automatic calculation for each point in the stroke (STC SYSTEM) | Separately adjustable slowdowns for each motor | Possibility of encoder or time-based operation even independently between the two motors | Built-in energy saving ESA SYSTEM+ | Advantouch system to configure parameters and manage radio transmitters | Number of manoeuvres | Programming access password | Maintenance warning

Integrated battery charger, compatible with two 12V, 1.2A batteries

Configurable output for 12/24 Vdc electric lock

Two outputs configurable as open gate indicator, courtesy light, area light, second radio channel, photocells test, flashing light, alarm contact

Accessory power supply output, 24 Vdc/0.5 A maximum with logic **ESA System+**

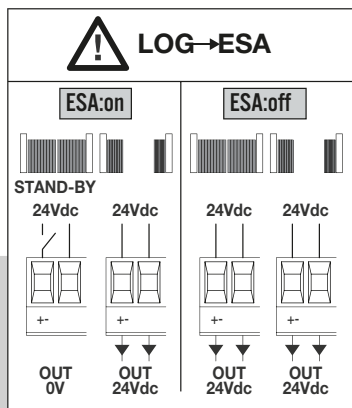

**INCLINED CONTROL UNIT SUPPORT AND INTEGRABLE BUFFER BATTERY**

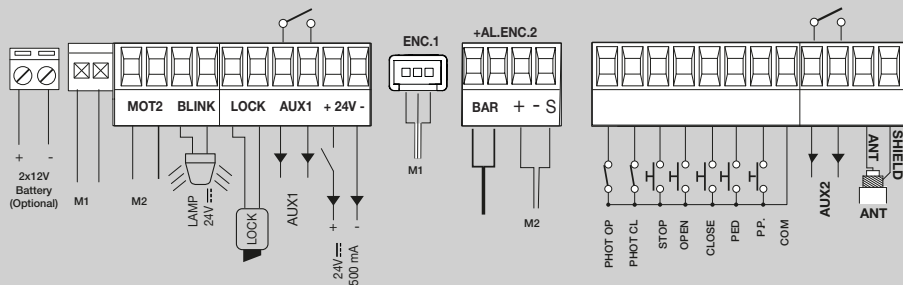
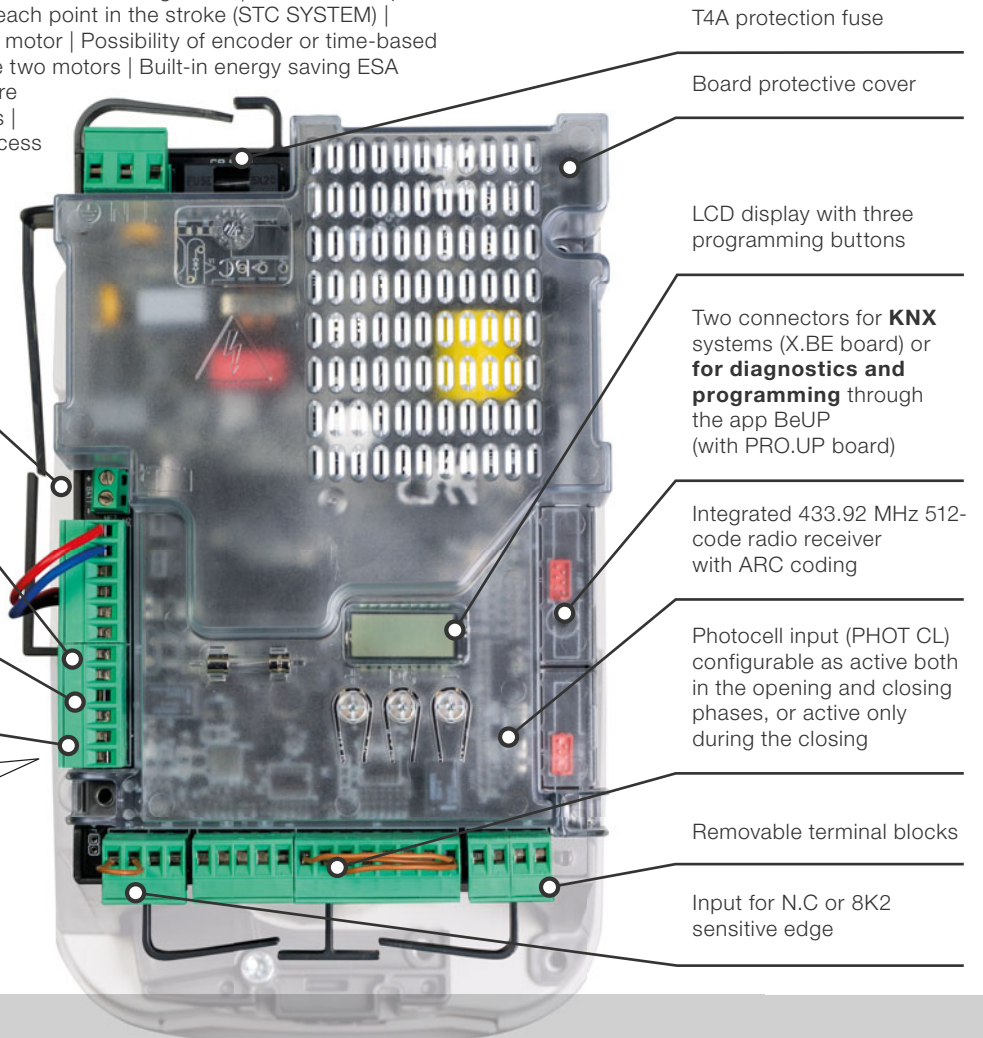

### EASY INSTALLATION

The adjustment of the mechanical stops is facilitated thanks to the removable control unit support

### INPUTS AND OUTPUTS

**Inputs** Separate encoder inputs for each motor (configurable as limit switch on box version), open, close, step, pedestrian and stop and separate inputs for photocell active in open-close and photocell active only in close. Input for N.C. or 8K2 sensitive edge.

**Output** configurable as open gate warning light or photocell test | Output configurable as second radio channel, service light or zone light



# Benincà's connectivity

## BeMOVE. AN APP FOR END-USERS

**BeMOVE** is the app that quickly connects your lights, automations, and garden irrigation system. You can control them through access time slots or **GPS positions**. This way, you can open the gate while you're getting home. With the Event function, you can easily make whatever you want, whenever you want. Even if you're not home. The **gateway HOOP** is the system's core. It interacts with the automations in mono and bidirectional mode as well as in a radio or wired mode. **g.MOVE** bidirectional transceivers show you the automation status. For example, if you've left the gate open, you can remotely check whether the lights are on. When you're away from home, you can check the automation status and enable them if needed using the **BeMOVE app**. You can also close the awnings if it starts raining.

The future is here.



bemove.beninca.com



**g.MOVE**



868 MHz module to install on control units for remote control through automation apps.

**hhoop**  
GATEWAY



Dialogue interface between the app and the connected devices.

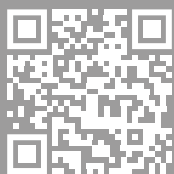

## BeUP. ESPECIALLY FOR PROFESSIONALS

Working smartly

**BeUP** is the new application for iOS and Android operating systems, dedicated to professionals. If combined with **PRO.UP**, it allows you to programme all Benincà control units in a fast and easy way, while being comfortably seated in your lorry. Moreover, by connecting **PRO.UP** to the **cloud server**, you can save the installations made for a specific system. For future maintenance, you can also consult the system's details, past interventions and update the firmware. There's more! The app allows you to program the **BeMOVE** systems, be always updated with the latest products, consult instruction manuals and access training courses.

Choose to do the best work you possibly can.

**PRO.UP**

Remote programming and diagnostics interface.



**SAM.BA**

Articulated arm.

**SAM.BS**

Sliding arm.

**SAM.SN**

Articulated arm for sloped gates.

**SAM.STOP**

 Additional mechanical stop.  
**Package of 2 pcs.**

**SAM.LOCK**

Lock with customised key.

**SAM.SE**

Externally fitted anti-intrusion cable unlock device which allows the gate to be unlocked from outside.

**DU.V96**

12 Vac/dc vertical electric lock, supplied with counterplate. Permits internal/external release.

**DU.V90**

12 Vac/dc horizontal electric lock, supplied with counterplate. Permits internal/external release.

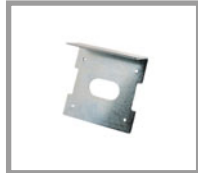
**DU.9990**

Covering plate for DU.V90.

**ID.TA**

Warning board.

**IRI.TX4VA**

4-channel transmitter with Advanced Rolling Code and Rolling Code.

**IRI.TX4AK**

4-channel transmitter with Advanced Rolling Code and Fixed Code.

**IRI.LAMP**

Flashing white light, 20÷255 Vac/dc with integrated antenna.

**IRI.KPAD**

Battery operated wireless vandal-proof digital keypad with alert buzzer and backlit buttons. Triple coding: Rolling Code, Programmable Code and Advanced Rolling Code. 254 memorisable codes.

**IRI.CELL**

Pair of vandal-proof metal covers for PUPILLA/PUPILLA.T photocells, comprising front and rear shells with concealed screw. They can maintain perfect orientation over 180°.

**PUPILLA**

Pair of photocells adjustable to 180°. Option to synchronise up to 4 pairs, 24 Vac/dc power supply. Easy adjustment through a LED that signals optimal alignment. Compact size: 36x110x35 mm

**SAM.CB**

 Brackets kit for installable batteries on board.  
**Package of 5 pcs.**

**X.BE**

Electronic interface board between the KNX communication system and Beninca automation devices.

**BENINCA**  
 TECHNOLOGY TO OPEN

**AUTOMATISMI BENINCA SpA**

Via del Capitello, 45  
 36066 Sandrigo (VI) ITALY  
 T +39 0444 751030  
 sales@beninca.com

[www.beninca.com](http://www.beninca.com)