

## DH-PFB203W

### Water-proof Wall Mount Bracket



### Features

- Material: Aluminum
- Wall Mount Bracket
- Neat & Integrated design

### Specifications

Model	DH-PFB203W
<b>General</b>	
Material	Aluminum
Dimension (L x W x H)	160mmx 122mm x 76mm
Operating Temperature	-40°C~60°C
Humidity	0~90% RH
Load Bearing	1.0kg
Weight	0.5kg
Color	White
Applicable Model	Please see "Accessory Selection"

# DH-PFB203W

## Dimensions (mm)

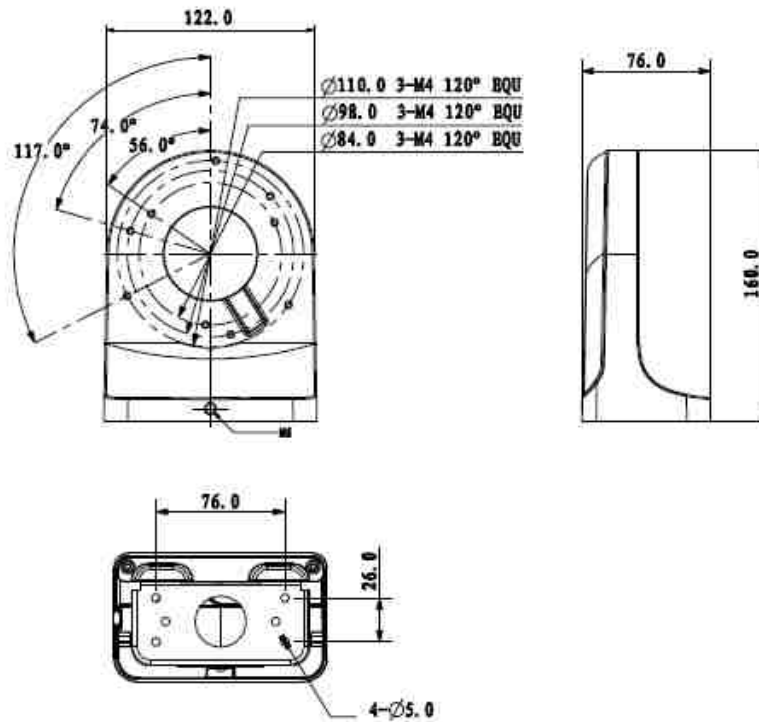

## Application

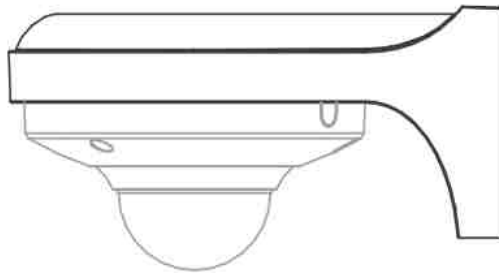

### Dahua Technology Co., Ltd.

1199BinAn Road, Binjiang District, Hangzhou, China

Tel: +86-571-87688883

Fax: +86-571-87688815

Email: [overseas@dahuatech.com](mailto:overseas@dahuatech.com)

[www.dahuasecurity.com](http://www.dahuasecurity.com)

\*Design and specifications are subject to change without notice.

© 2013Dahua Technology Co., Ltd.